

مدارات فرمان و قدرت طراحی شده با

EKTS

&

PLC



آموزشگاه فنی مهندسی کیان

طراحی و تنظیم:

مهندس میثم همتی

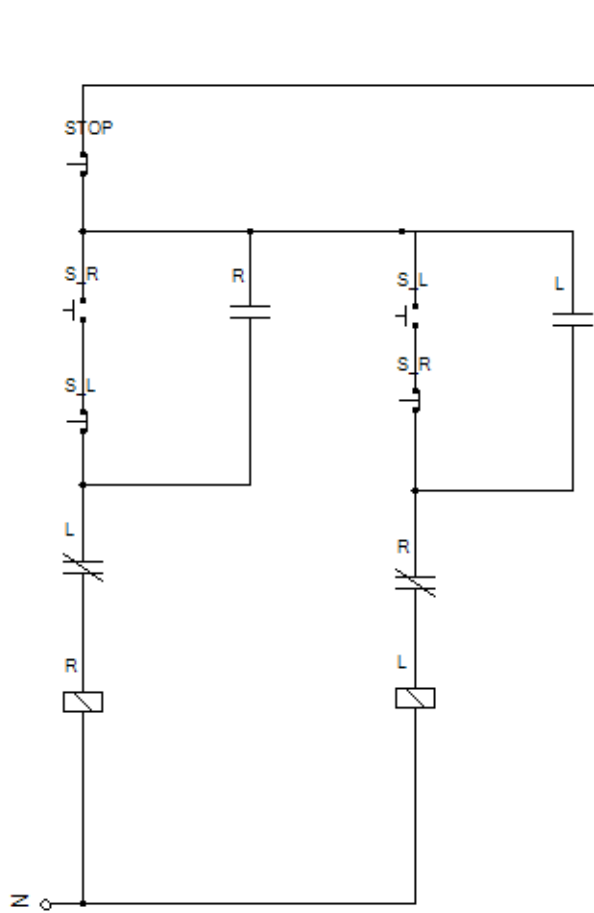



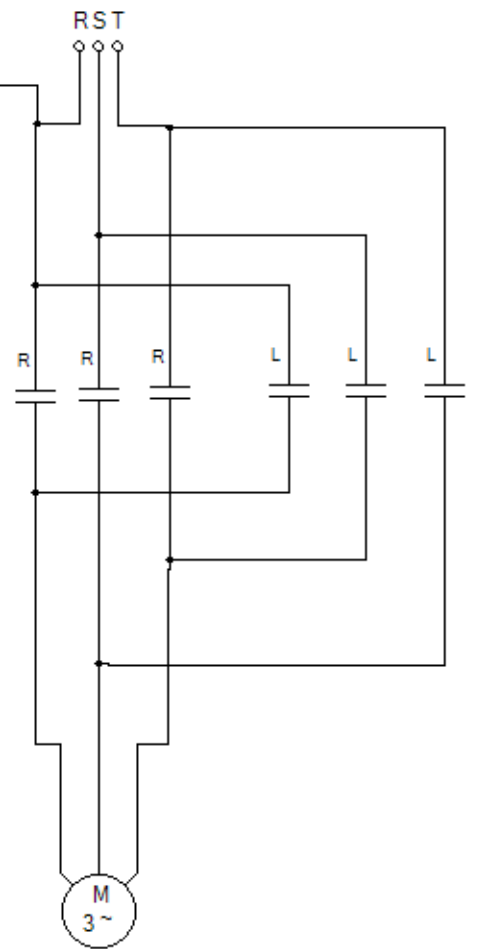





موتور جیگردد راست گرد
با حفاظت کابل



شرکت فنی مهندسی پتروکیان

م. هوشی

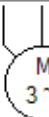
petrokiyan.com

	Element	Quantity	Label		
	Start Button	2			
	Stop Button	3			
	Contactor	2	L R	4 4	1 1
N 	Neutral	1			
	Three Phase Induction Motor	1			
RST 	3-Phase Supply	1			

OB1 - <offline>

"WWW.PETROKIYAN.COM"

Tel: 066-33337622

Mob: 09165453133

Name: MEYSAM**Family:** HEMATI**Author:** کیان**Version:** 0.1**Block version:** 2**Time stamp Code:**

01/16/2015 04:00:41 PM

Interface:

02/15/1996 04:51:12 PM

Lengths (block/logic/data): 00148 00034 00020

Name	Data Type	Address	Comment
TEMP		0.0	
OB1_EV_CLASS	Byte	0.0	Bits 0-3 = 1 (Coming event), Bits 4-7 = 1 (Event class 1)
OB1_SCAN_1	Byte	1.0	1 (Cold restart scan 1 of OB 1), 3 (Scan 2-n of OB 1)
OB1_PRIORITY	Byte	2.0	Priority of OB Execution
OB1_OB_NUMBR	Byte	3.0	1 (Organization block 1, OB1)
OB1_RESERVED_1	Byte	4.0	Reserved for system
OB1_RESERVED_2	Byte	5.0	Reserved for system
OB1_PREV_CYCLE	Int	6.0	Cycle time of previous OB1 scan (milliseconds)
OB1_MIN_CYCLE	Int	8.0	Minimum cycle time of OB1 (milliseconds)
OB1_MAX_CYCLE	Int	10.0	Maximum cycle time of OB1 (milliseconds)
OB1_DATE_TIME	Date_And_Time	12.0	Date and time OB1 started

Block: OB1 "Main Program Sweep (Cycle)"

شرکت فنی مهندسی پترو کیان افلاک

WWW.PETROKIYAN.COM

TEL:066-33337622

DESIGNER : MEYSAM HEMTATI

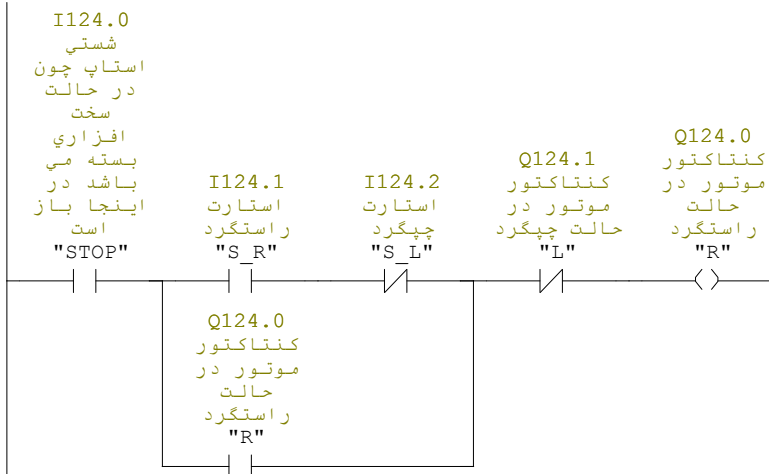
Network: 1 کنتاکتور موتور در حالت راستگرد

Network: 2 کنتاکتور موتور در حالت چپگرد

I124.0
شستی
استاپ چون
در حالت
سخت
افزاري
بسته مي
باشد در
اينجا باز
است
"STOP"

I124.2
استارت
چپگرد
"S_L"

I124.1
استارت
راستگرد
"S_R"

Q124.0
کنتاکتور
موتور در
حالت
راستگرد
"R"

Q124.1
کنتاکتور
موتور در
حالت چپگرد
"L"

Q124.1
کنتاکتور
موتور در
حالت چپگرد
"L"

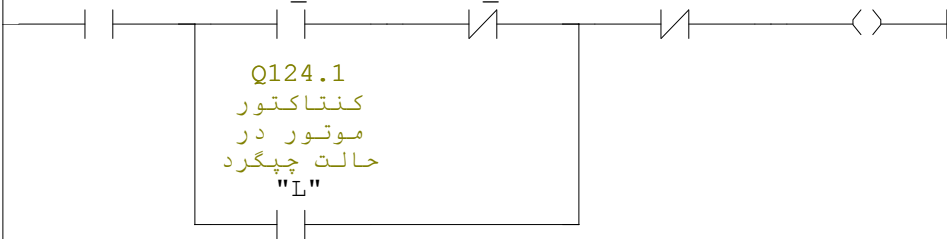

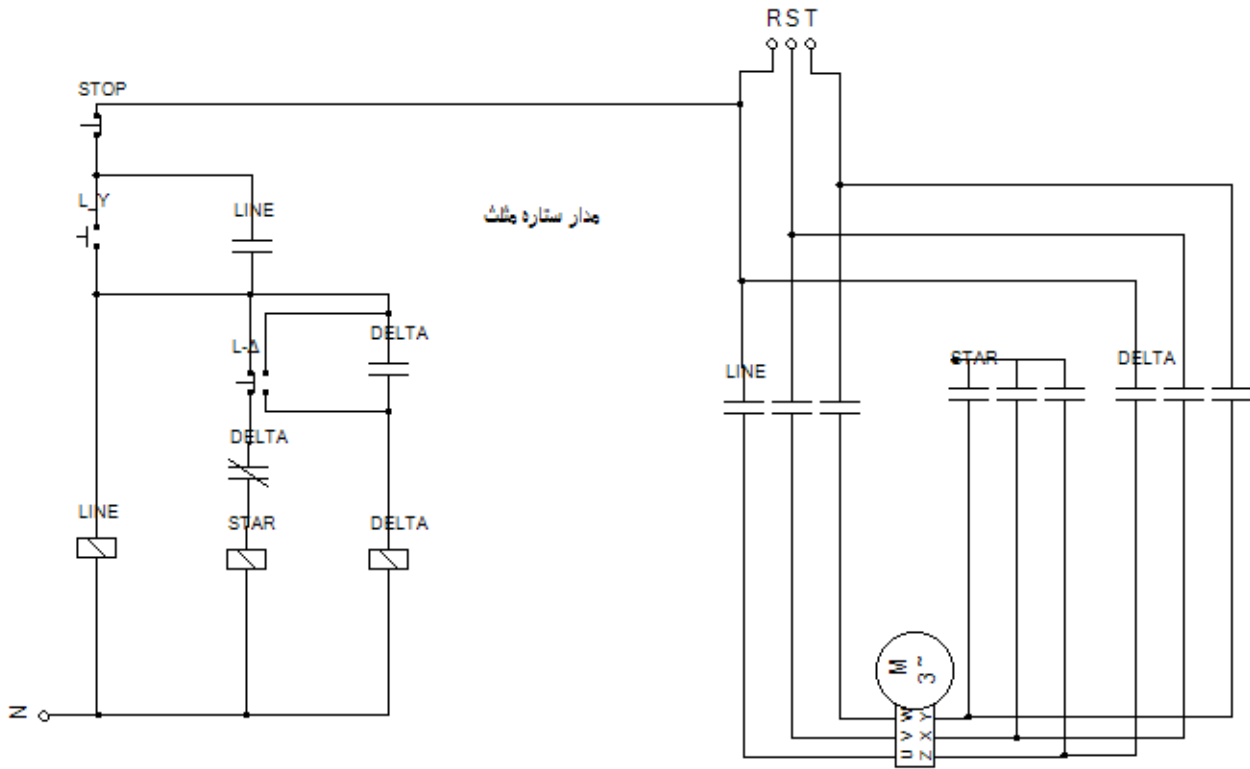

آموزشگاه فنی کیان

م. هفتی

petrokiyan.com

	Element	Quantity	Label		
	Star-Delta Connectible 3 Phase Induction Motor	1			
	3-Phase Supply	1			
	Contactor	3	DELTA STAR LINE	4 3 4	1 0 0
	Two way button	1			
	Neutral	1			
	Stop Button	1			
	Start Button	1			

OB1 - <offline>

""

Name: **Family:**
Author: **Version:** 0.1
Block version: 2
Time stamp Code: 01/16/2015 01:10:09 PM
Interface: 02/15/1996 04:51:12 PM
Lengths (block/logic/data): 00154 00038 00020

Name	Data Type	Address	Comment
TEMP		0.0	
OB1_EV_CLASS	Byte	0.0	Bits 0-3 = 1 (Coming event), Bits 4-7 = 1 (Event class 1)
OB1_SCAN_1	Byte	1.0	1 (Cold restart scan 1 of OB 1), 3 (Scan 2-n of OB 1)
OB1_PRIORITY	Byte	2.0	Priority of OB Execution
OB1_OB_NUMBR	Byte	3.0	1 (Organization block 1, OB1)
OB1_RESERVED_1	Byte	4.0	Reserved for system
OB1_RESERVED_2	Byte	5.0	Reserved for system
OB1_PREV_CYCLE	Int	6.0	Cycle time of previous OB1 scan (milliseconds)
OB1_MIN_CYCLE	Int	8.0	Minimum cycle time of OB1 (milliseconds)
OB1_MAX_CYCLE	Int	10.0	Maximum cycle time of OB1 (milliseconds)
OB1_DATE_TIME	Date_And_Time	12.0	Date and time OB1 started

Block: OB1 "Main Program Sweep (Cycle)"

Network: 1 کنتاکتور خط

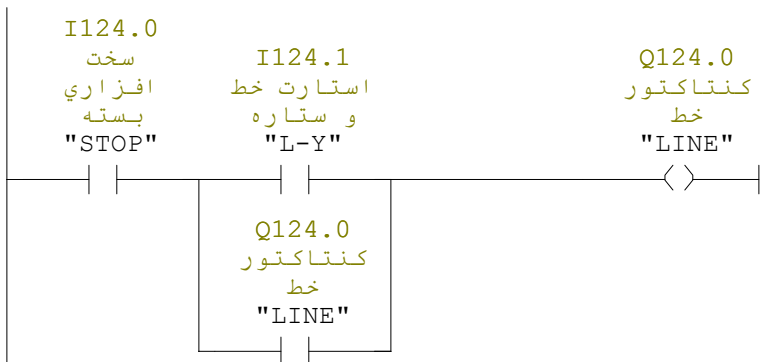

Network: 2 کنتاکتور ستاره



Network: 3 کنتاکتور مثلث

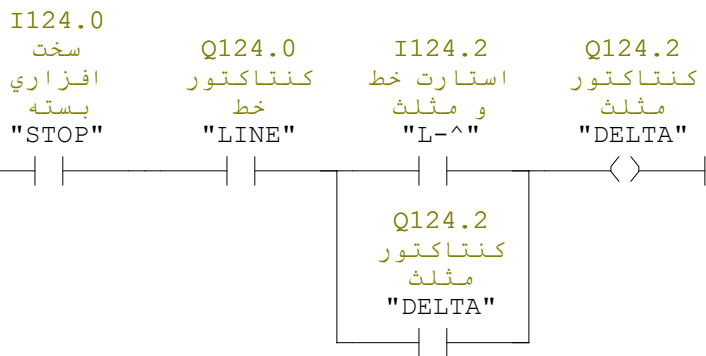

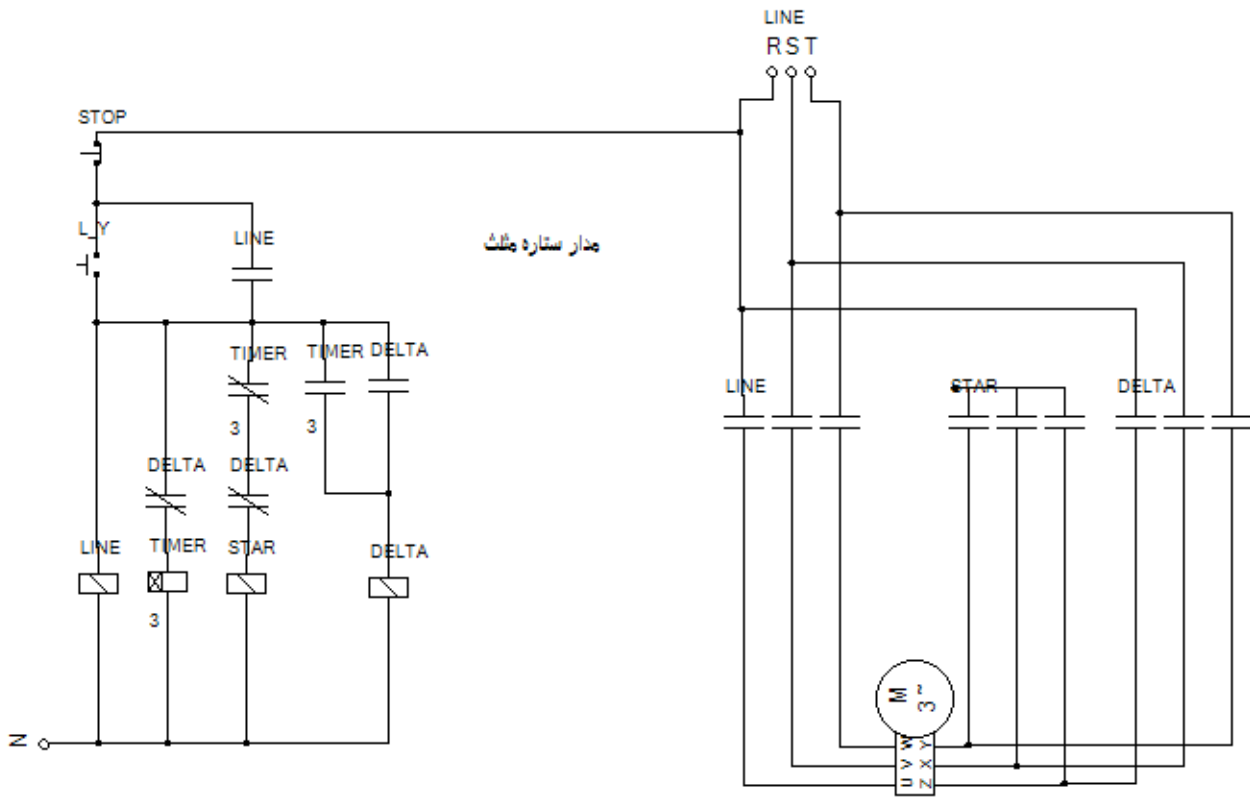

آموزشگاه فنی کیان

م. هشتی

petrokiyan.com

	Element	Quantity	Label		
	Contactor	3	STAR LINE DELTA	3 4 4	0 0 2
	On-delay Time Relay	1	TIMER	1	1
	Star-Delta Connectible 3 Phase Induction Motor	1			
	3-Phase Supply	1			
	Neutral	1			
	Stop Button	1			
	Start Button	1			

OB1 - <offline>

"WWW.PETROKIYAN.COM"

Tel : 066-33337622

Mob: 09165453133

Name: MEYSAM**Family:** HEMATI**Author:** كيان**Version:** 0.1**Block version:** 2**Time stamp Code:**

01/16/2015 12:58:09 PM

Interface:

02/15/1996 04:51:12 PM

Lengths (block/logic/data): 00178 00058 00020

Name	Data Type	Address	Comment
TEMP		0.0	
OB1_EV_CLASS	Byte	0.0	Bits 0-3 = 1 (Coming event), Bits 4-7 = 1 (Event class 1)
OB1_SCAN_1	Byte	1.0	1 (Cold restart scan 1 of OB 1), 3 (Scan 2-n of OB 1)
OB1_PRIORITY	Byte	2.0	Priority of OB Execution
OB1_OB_NUMBR	Byte	3.0	1 (Organization block 1, OB1)
OB1_RESERVED_1	Byte	4.0	Reserved for system
OB1_RESERVED_2	Byte	5.0	Reserved for system
OB1_PREV_CYCLE	Int	6.0	Cycle time of previous OB1 scan (milliseconds)
OB1_MIN_CYCLE	Int	8.0	Minimum cycle time of OB1 (milliseconds)
OB1_MAX_CYCLE	Int	10.0	Maximum cycle time of OB1 (milliseconds)
OB1_DATE_TIME	Date_And_Time	12.0	Date and time OB1 started

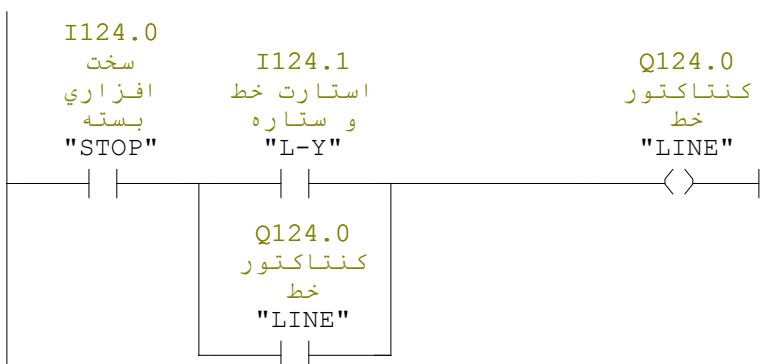
Block: OB1 "Main Program Sweep (Cycle)"**Network: 1** كنتاكتور خط

Network: 2 تاخير در وصل دائم

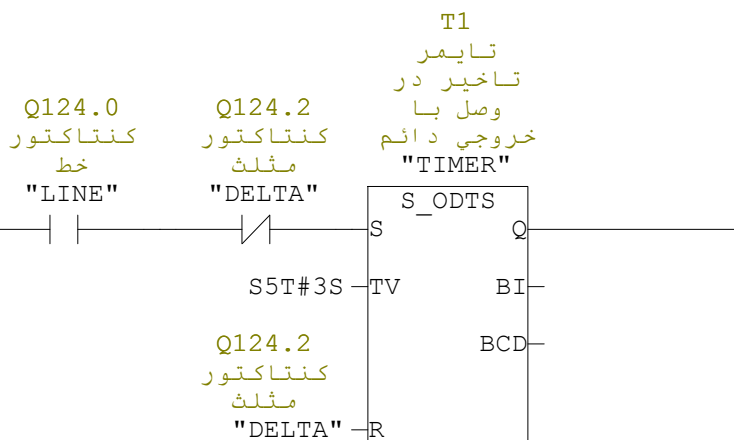

Network: 3 کنتاکتور ستاره

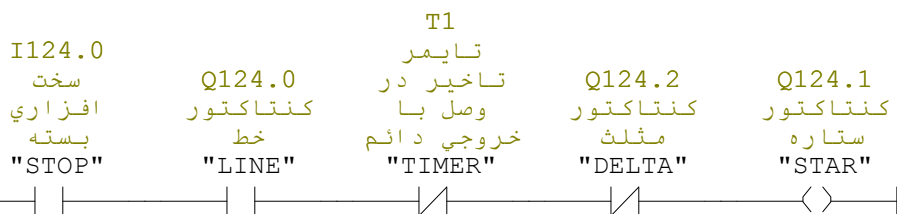

Network: 4 کنتاکتور مثلث

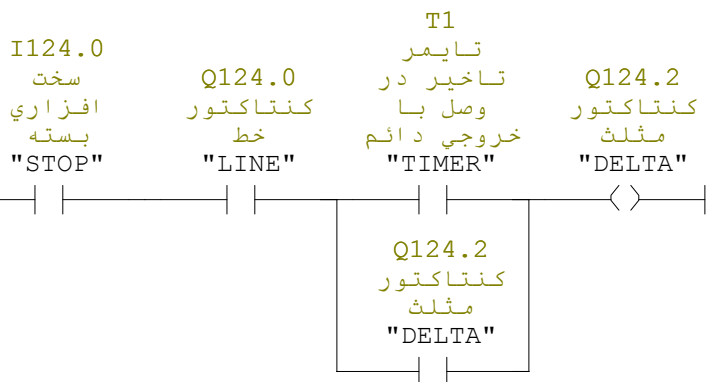

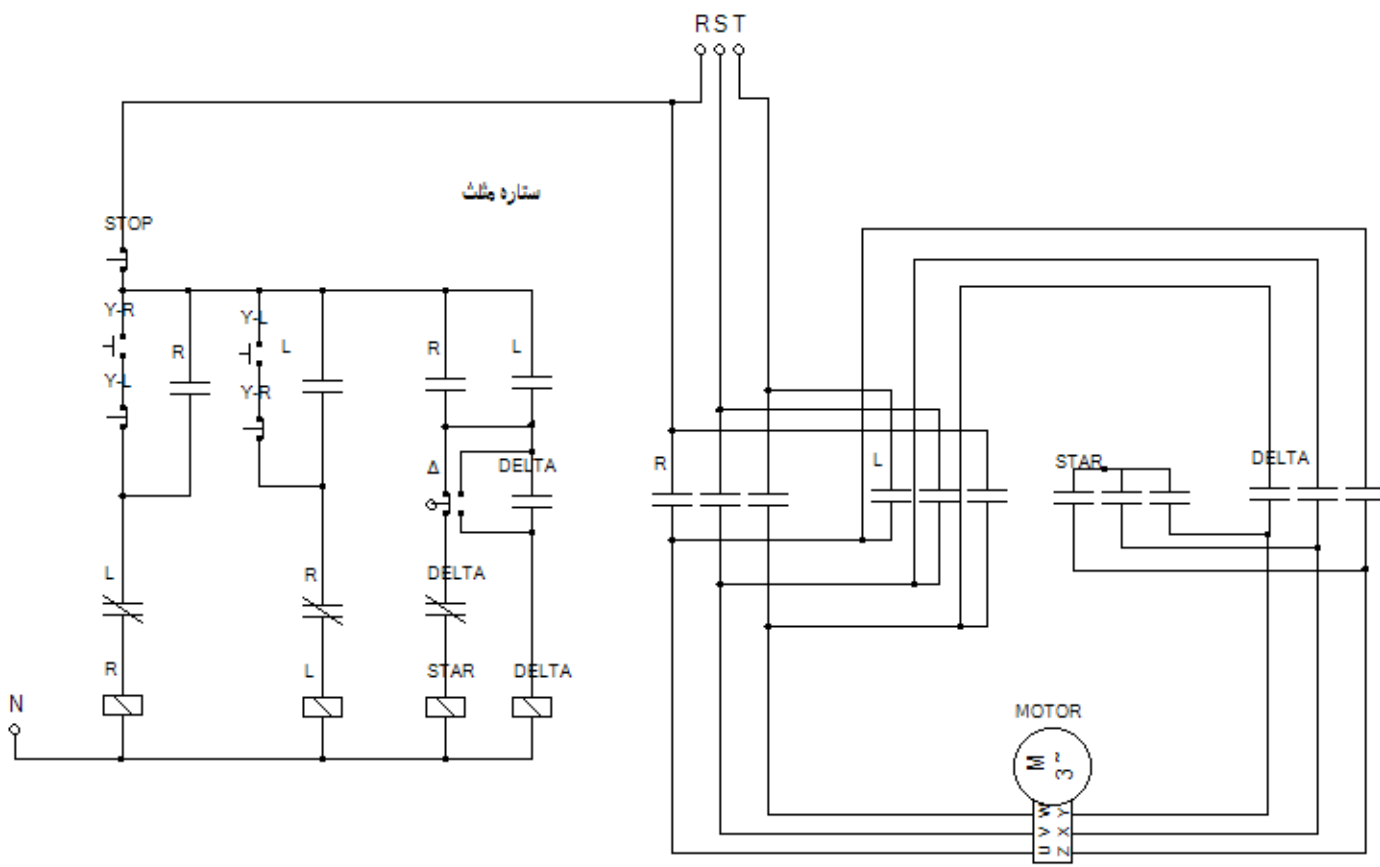









شرکت فنی مهندسی پتروکیان

م. هجوتی

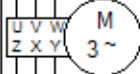
petrokiyan.com

	Element	Quantity	Label		
	Start Button	2			
	Contactor	4	L DELTA R STAR	5 4 5 3	1 1 1 0
	Stop Button	3			
N 	Neutral	1			
RST 	3-Phase Supply	1			
	Star-Delta Connectible 3 Phase Induction Motor	1			
	Limit switch(two pole)	1			

OB1 - <offline>

"WWW.PETROKIYAN.COM"

Tel: 066-33337622

Mob: 09165453133

Name: MEYSAM**Family:** HEMATI**Author:** کیان**Version:** 0.1**Block version:** 2**Time stamp Code:**

01/16/2015 03:08:39 PM

Interface:

02/15/1996 04:51:12 PM

Lengths (block/logic/data): 00188 00070 00020

Name	Data Type	Address	Comment
TEMP		0.0	
OB1_EV_CLASS	Byte	0.0	Bits 0-3 = 1 (Coming event), Bits 4-7 = 1 (Event class 1)
OB1_SCAN_1	Byte	1.0	1 (Cold restart scan 1 of OB 1), 3 (Scan 2-n of OB 1)
OB1_PRIORITY	Byte	2.0	Priority of OB Execution
OB1_OB_NUMBR	Byte	3.0	1 (Organization block 1, OB1)
OB1_RESERVED_1	Byte	4.0	Reserved for system
OB1_RESERVED_2	Byte	5.0	Reserved for system
OB1_PREV_CYCLE	Int	6.0	Cycle time of previous OB1 scan (milliseconds)
OB1_MIN_CYCLE	Int	8.0	Minimum cycle time of OB1 (milliseconds)
OB1_MAX_CYCLE	Int	10.0	Maximum cycle time of OB1 (milliseconds)
OB1_DATE_TIME	Date_And_Time	12.0	Date and time OB1 started

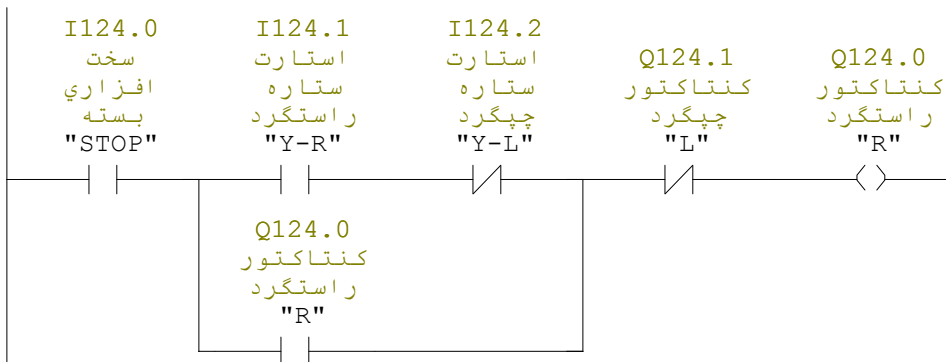
Block: OB1 "Main Program Sweep (Cycle)"**Network: 1** کنتاکتور راستگرد

Network: 2 کنتاکتور چپگرد

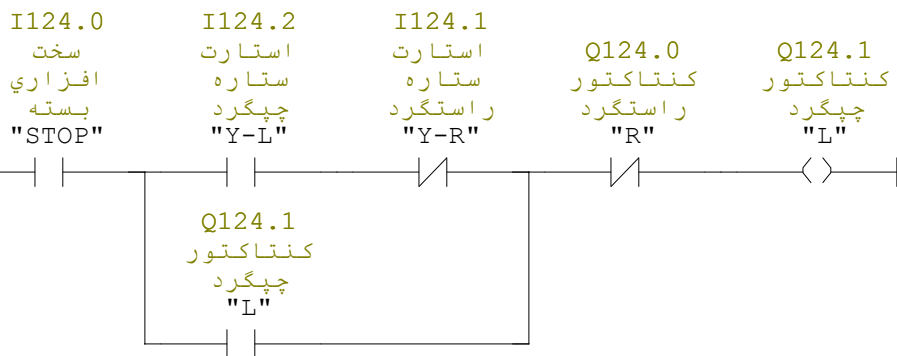

Network: 3 کنتاکتور ستاره

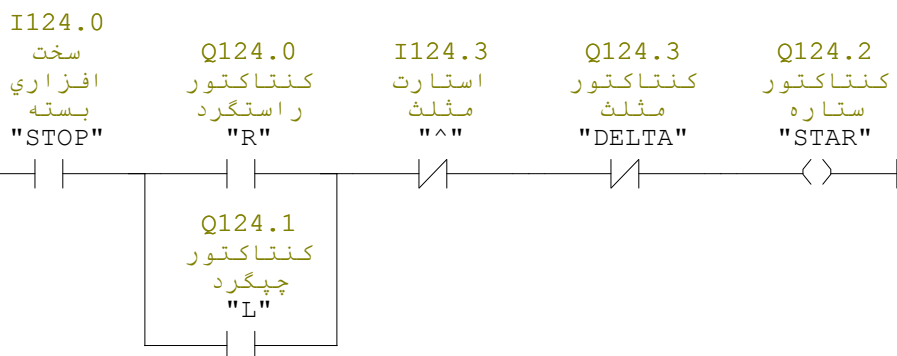

Network: 4 کنتاکتور مثلث

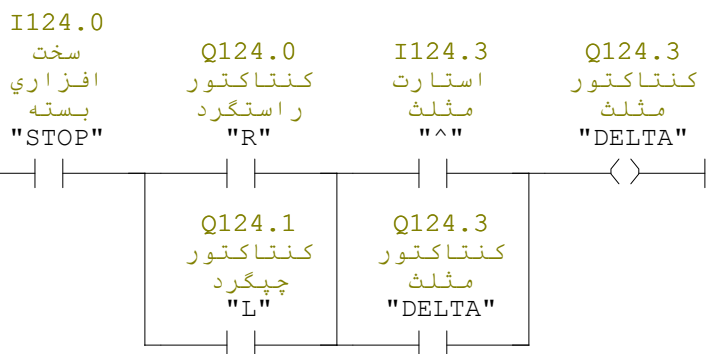

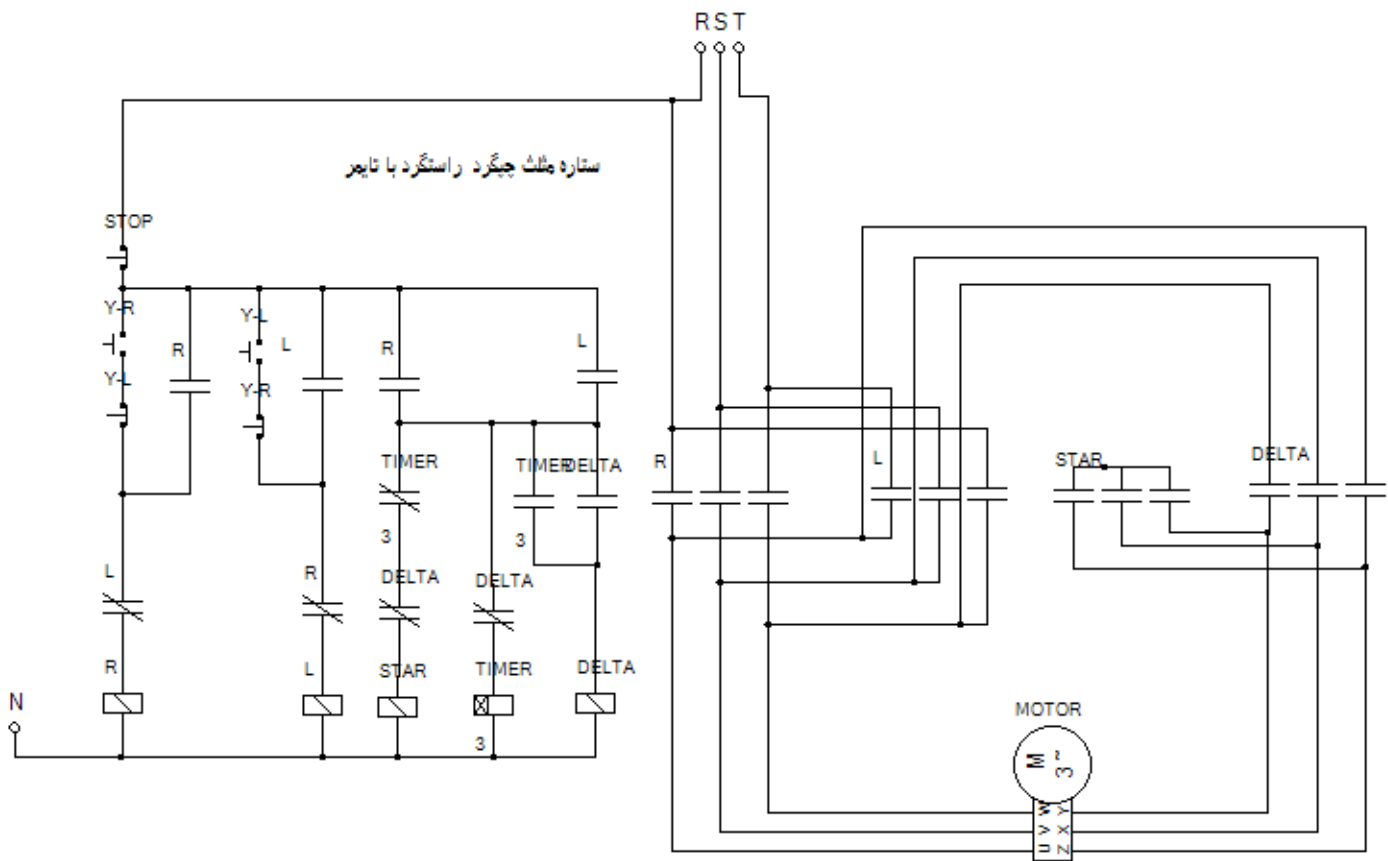









شرکت فنی مهندسی پتروکیان

م. هجینی

petrokiyan.com

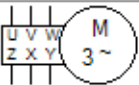
	Element	Quantity	Label		
	On-delay Time Relay	1	TIMER	1	1
	Contactor	4	DELTA STAR L R	4 3 5 5	2 0 1 1
	Start Button	2			
	Stop Button	3			
N 	Neutral	1			
RST 	3-Phase Supply	1			
	Star-Delta Connectible 3 Phase Induction Motor	1			

OB1 - <offline>

"WWW.PETROKIYAN.COM"

Tel: 066-33337622

Mob: 09165453133

Name: MEYSAM**Family:** HEMATI**Author:** کیان**Version:** 0.1**Block version:** 2**Time stamp Code:**

01/16/2015 03:54:59 PM

Interface:

02/15/1996 04:51:12 PM

Lengths (block/logic/data): 00214 00094 00020

Name	Data Type	Address	Comment
TEMP		0.0	
OB1_EV_CLASS	Byte	0.0	Bits 0-3 = 1 (Coming event), Bits 4-7 = 1 (Event class 1)
OB1_SCAN_1	Byte	1.0	1 (Cold restart scan 1 of OB 1), 3 (Scan 2-n of OB 1)
OB1_PRIORITY	Byte	2.0	Priority of OB Execution
OB1_OB_NUMBR	Byte	3.0	1 (Organization block 1, OB1)
OB1_RESERVED_1	Byte	4.0	Reserved for system
OB1_RESERVED_2	Byte	5.0	Reserved for system
OB1_PREV_CYCLE	Int	6.0	Cycle time of previous OB1 scan (milliseconds)
OB1_MIN_CYCLE	Int	8.0	Minimum cycle time of OB1 (milliseconds)
OB1_MAX_CYCLE	Int	10.0	Maximum cycle time of OB1 (milliseconds)
OB1_DATE_TIME	Date_And_Time	12.0	Date and time OB1 started

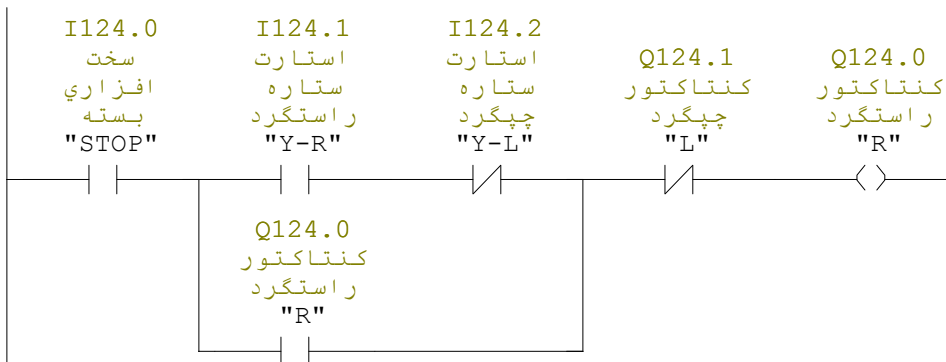
Block: OB1 "Main Program Sweep (Cycle)"**Network: 1** کنتاکتور راستگرد

Network: 2 کنتاکتور چپگرد

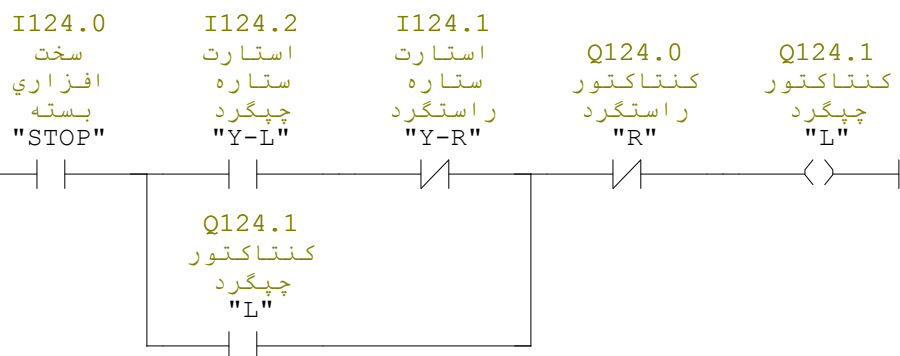

Network: 3

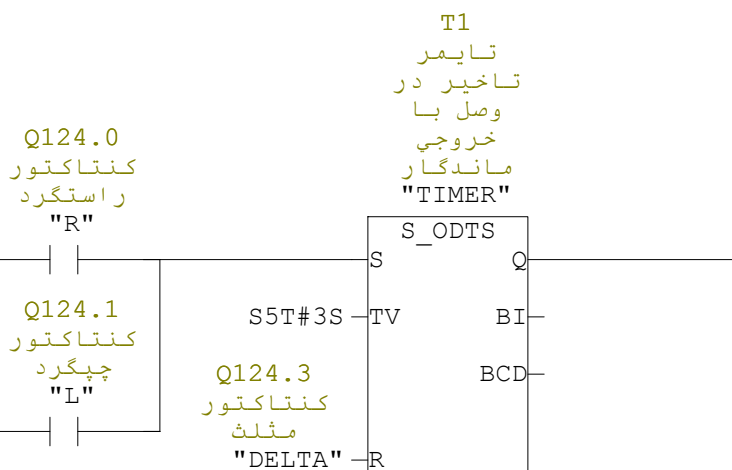

Network: 4 کنتاکتور ستاره

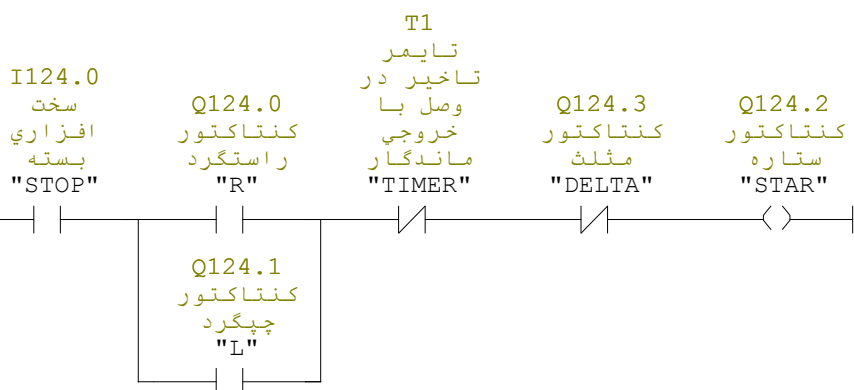

Network: 5 کنتاکتور مثلث

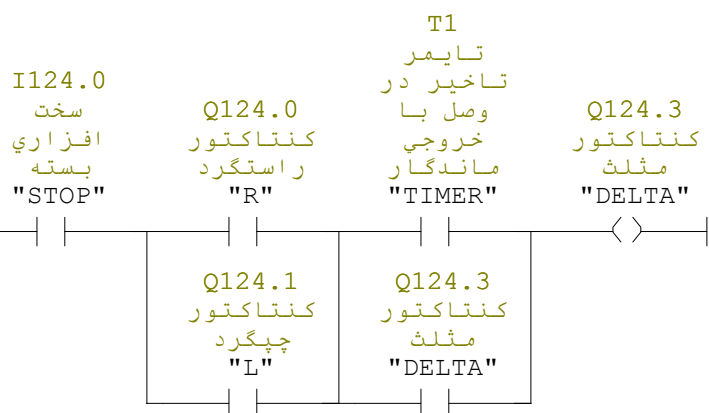

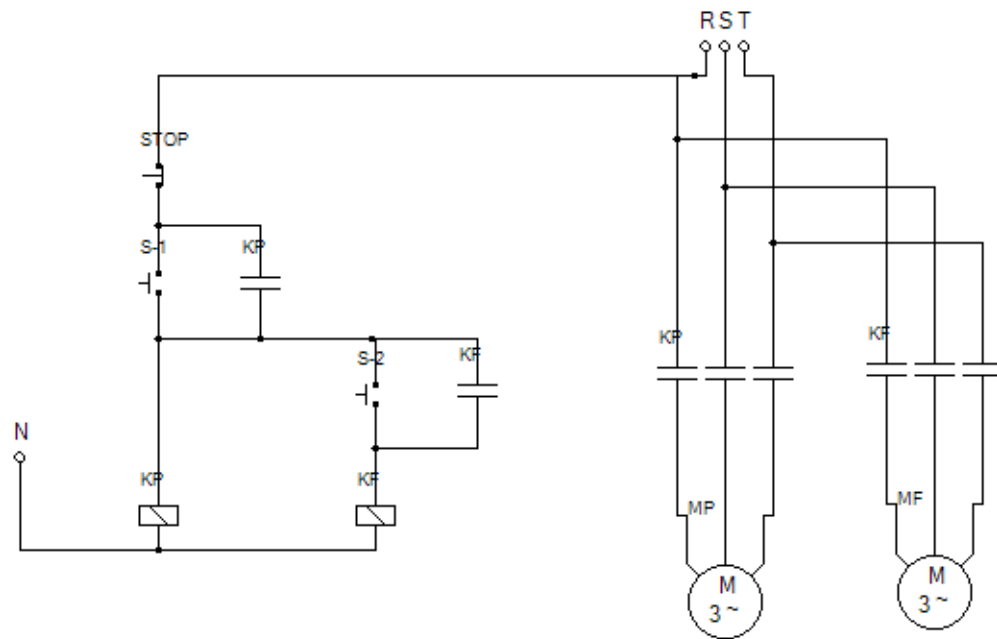

مدار یکی پس از دیگری

	Element	Quantity	Label		
	Contactor	2	KF KP	4	0
	Start Button	2			
	Neutral	1			
	Stop Button	1			
	Three Phase Induction Motor	2			
	3-Phase Supply	1			

OB1 - <offline>

""

Name: **Family:**
Author: **Version:** 0.1
Block version: 2
Time stamp Code: 01/17/2015 06:20:05 PM
Interface: 02/15/1996 04:51:12 PM
Lengths (block/logic/data): 00142 00028 00020

Name	Data Type	Address	Comment
TEMP		0.0	
OB1_EV_CLASS	Byte	0.0	Bits 0-3 = 1 (Coming event), Bits 4-7 = 1 (Event class 1)
OB1_SCAN_1	Byte	1.0	1 (Cold restart scan 1 of OB 1), 3 (Scan 2-n of OB 1)
OB1_PRIORITY	Byte	2.0	Priority of OB Execution
OB1_OB_NUMBR	Byte	3.0	1 (Organization block 1, OB1)
OB1_RESERVED_1	Byte	4.0	Reserved for system
OB1_RESERVED_2	Byte	5.0	Reserved for system
OB1_PREV_CYCLE	Int	6.0	Cycle time of previous OB1 scan (milliseconds)
OB1_MIN_CYCLE	Int	8.0	Minimum cycle time of OB1 (milliseconds)
OB1_MAX_CYCLE	Int	10.0	Maximum cycle time of OB1 (milliseconds)
OB1_DATE_TIME	Date_And_Time	12.0	Date and time OB1 started

Block: OB1 "Main Program Sweep (Cycle)"

Network: 1 کنتاکتور پمپ

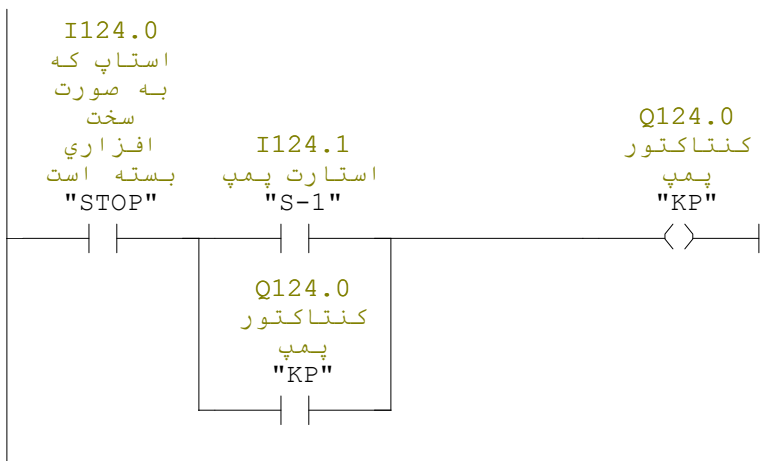

Network: 2 کنتاکتور فرز

